

CULTURED MARBLE BOWL OPTIONS

“WAVE” BOWL (W)

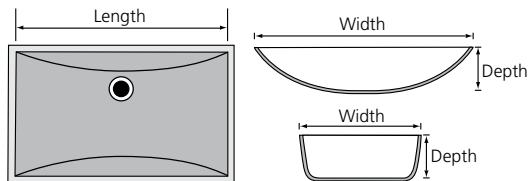

	Bowl Size		
	Length	Width	Depth
22" Top	19¼"	11¾"	5½"
19" Top	17¼"	10"	5¼"

STANDARD OVAL BOWL (O)

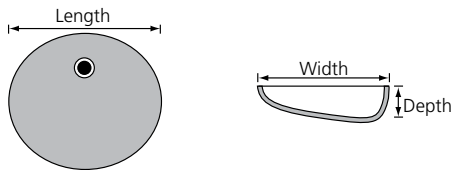

ADA	22" Standard Oval Bowl Available ADA Compliant. When ordering, add "-ADA" at the end of item code.		
	Bowl Size		
	Length	Width	Depth
22" Top	17"	13⅝"	5½"
19" Top	15¼"	11¾"	5⅝"
17" Top	15⅙"	10⅞"	6"

RECTANGULAR BOWL (RECT)

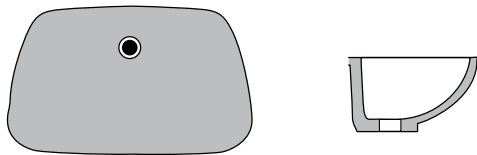

ADA	22" Rectangular Bowl Available ADA Compliant. When ordering, add "-ADA" at the end of item code.		
	Bowl Size		
	Length	Width	Depth
22" Top	17¾"	11"	5¼"
19" Top	17¾"	11"	5¼"

RECESSED OVAL BOWL (RCO)

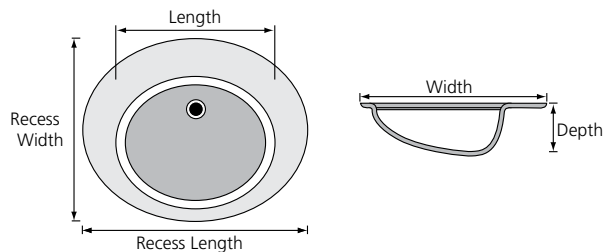

	Bowl Size			Recess Size	
	Length	Width	Depth	Length	Width
22" Top	17⅝"	12⅞"	6"	23"	18¼"
19" Top	15⅝"	10⅝"	6"	21¼"	16⅝"

RECESSED RECTANGULAR BOWL (RSQ)

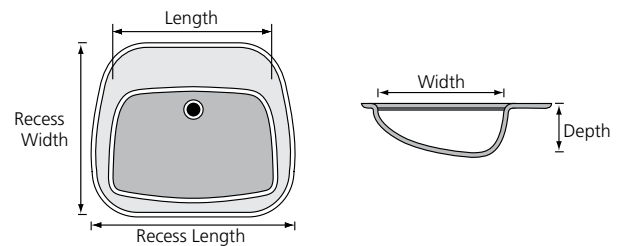

	Bowl Size			Recess Size	
	Length	Width	Depth	Length	Width
22" Top	17¾"	11½"	7⅞"	22½"	18¼"
19" Top	16"	10¼"	7"	19½"	16"

NOTE:

Overall length, width and placement dimensions may vary ¼" to ½".

All bowls come with an overflow. If you do NOT want an overflow, you must specify.

Depth measured inside bowl.

All dimensions are nominal.

CULTURED MARBLE VANITY TOP OPTIONS

CUSTOM OPTIONS

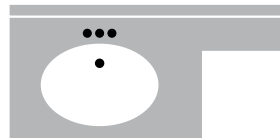

Banjo Tops

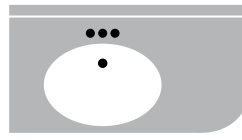

Radius Corners

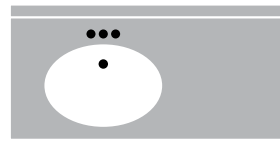

Offset Bowl

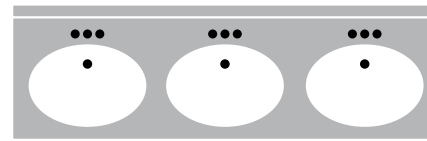

Extra Bowls

CORNER TOPS

Corner tops are also available in spray granite, onyx and color coordinates by special order.

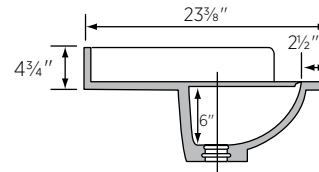
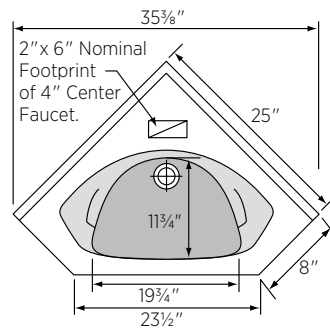

DECK DIMENSIONS

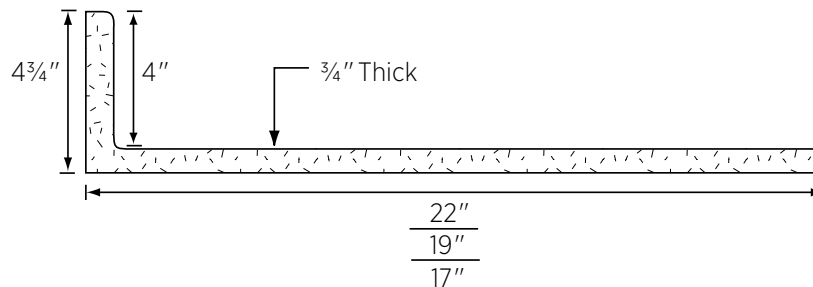

All dimensions are nominal.

1917 Mini = 19" x 17" deep with 2 7/8" splash

1917 Micro = 18 1/2" x 16 1/2" deep, with 2 1/4" splash